

# NEW

These new scientific developments of the Parker research laboratory

"easy-press" filler

visible  
ink supply

five-point  
thermal control

Parker Pli-glass  
reservoir

new colors—  
clip, caps, points

silver automatic  
pressure equalizer

# 1921

## the big red Parker Duo-fold

introduced color in pens for the first time . . . an immediate hit with the public.  
Prior to this time all fountain pens were black.

# 1932

## the Parker Vacumatic

the first practicable sacless pen. It inaugurated a new vogue in pen styling . . . transparent laminated pearl rings. It also introduced a new multiple action filling mechanism which eliminated unsightly side fillers.

# 1941

## the sensational Parker "51"

which introduced the first and only fountain pen which "writes dry with wet ink." This pen also presented to the public for the first time the concealed nib; the solid-color opaque Lucite barrel; the contrasting metal slip-on cap; and the concealed filler.

# 1948

*Another Link*

in Parker's chain of scientific developments

# ve revolutionized the writing instrument industry

*Every link in the chain of Parker's success has been securely welded by years of painstaking research . . . plus the courage and foresight to launch the new and unusual. This Parker policy has invariably inaugurated new trends in the writing industry.*

AND NOW . . .

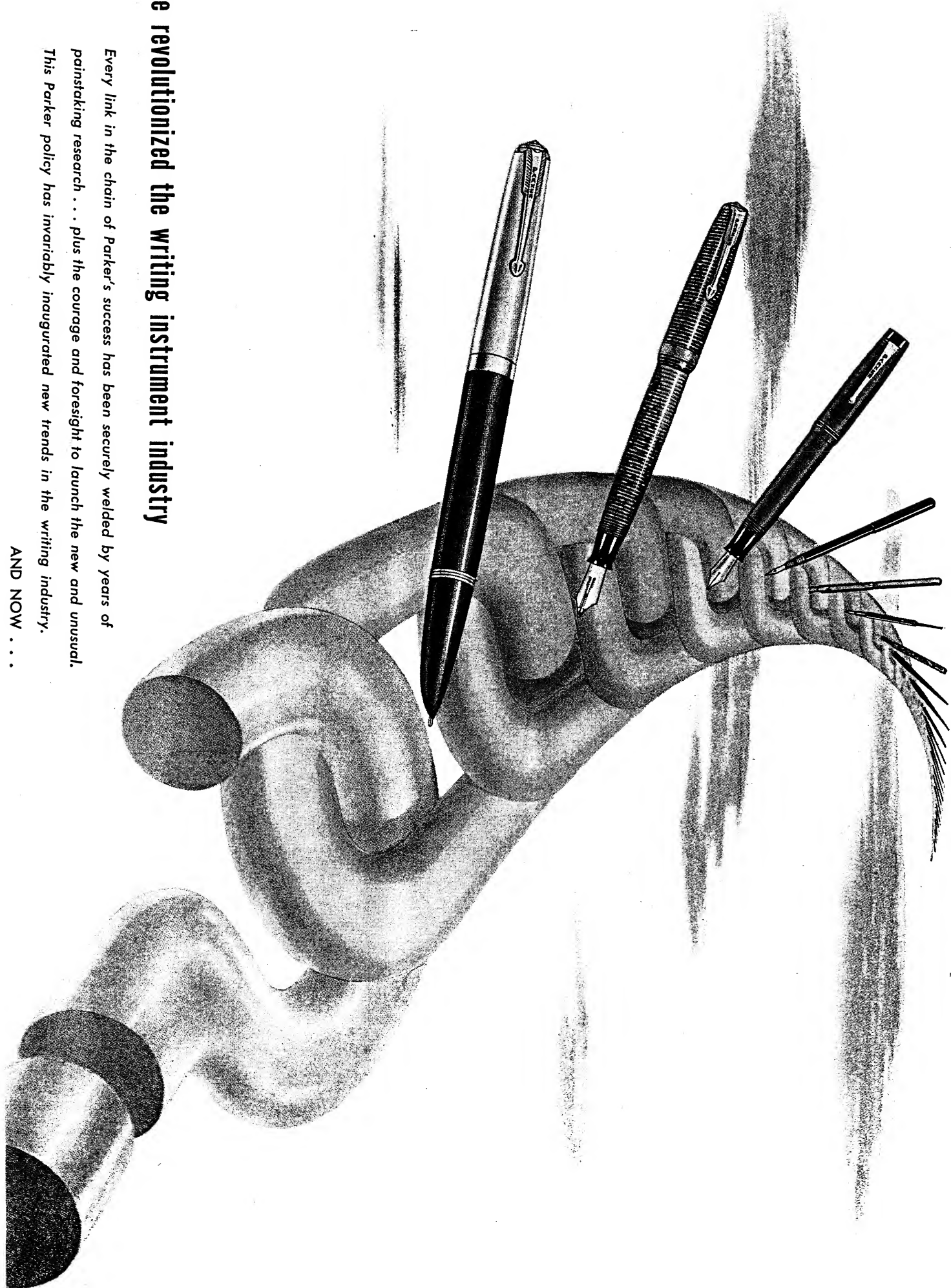

# The New PARKER "51" with

*Flow-Matic*

combines the finest features of the original Pa

## New—Sterling Silver Pressure Equalizer

This pressure equalizer is especially designed to reduce the possibility of leakage when pen undergoes altitude and temperature changes. A micromatic opening in a silver breather tube allows air to escape before pressure can build up internally.

If this build-up were not avoided, pressure would expel ink through the pen point.

The new Parker "51" diminishes danger of pen flooding while ascending or descending in airplanes. And, it will not leak due to temperature changes normally encountered. You can expect dependable operation from the new Parker "51" at altitudes up to 35,000 feet. Commercial airlines never exceed this height.



# pressure control

"51" with these new scientific developments

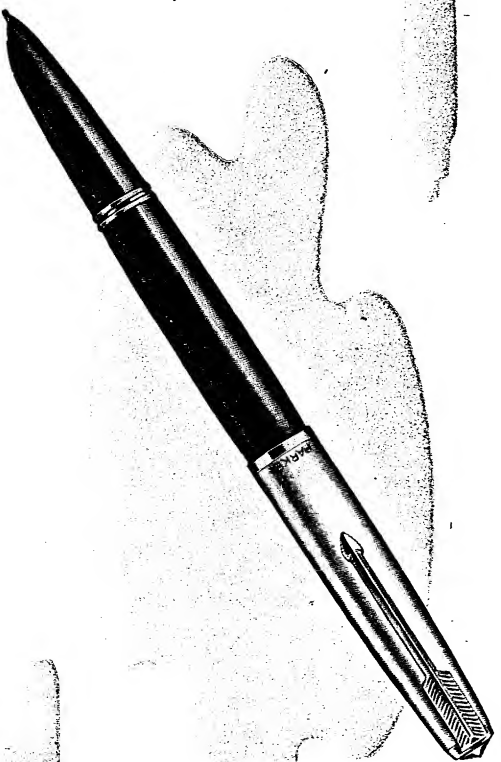

## New—Visible Ink Supply

Now you can see the ink supply in the new Parker "51", for Parker Pli-glass is translucent. Thus, you can determine the quantity of ink in your pen so that it never need run dry. To check your supply, unscrew barrel at clutch-ring, revealing the ink indicator window in metal shield. Hold pen "point up."

## New—5-Point Thermal Control

1. Lucite Pen Barrel
2. Air blanket between barrel and Pli-glass reservoir guard
3. Reservoir Guard
4. Air blanket guard and Pli-glass reservoir
5. Pli-glass (plastic) reservoir

\*Protecting the Pli-glass reservoir and breather tube is a metal guard. This guard adds considerably to the interior beauty of the pen. It performs various functional duties, one of which is the insulation against temperature variations within the pen. Also, it embodies this unique feature: Parker has engraved complete filling instructions on this metal guard. This is perhaps the first time that printed instructions have been made an integral part of a writing instrument.

# *Dependability*

Here you see the Parker blueprint for precision craftsmanship designs during progressive stages of development. Material and peerless performance. The indicated tolerances for this is thoroughly examined on arrival. Delicate machines then flow-control unit are held to minute specifications in order probe for defects throughout various stages of sub-assembly. to ensure thorough performance for every "51". Indeed, this Finally, the finished pen, already tested 42 times, is exposed pen — a triumph of Parker design — is crafted as precisely as to a series of exacting writing tests. Thus, Parker safeguards the finest timepiece. Another example of Parker quality control its cherished reputation for quality and provides a writing instrument for "51" owners which is paralleled by no other pen. is the constant testing and re-testing of material and new

THE INSIDE STORY OF THE FAMED PARKER "51"

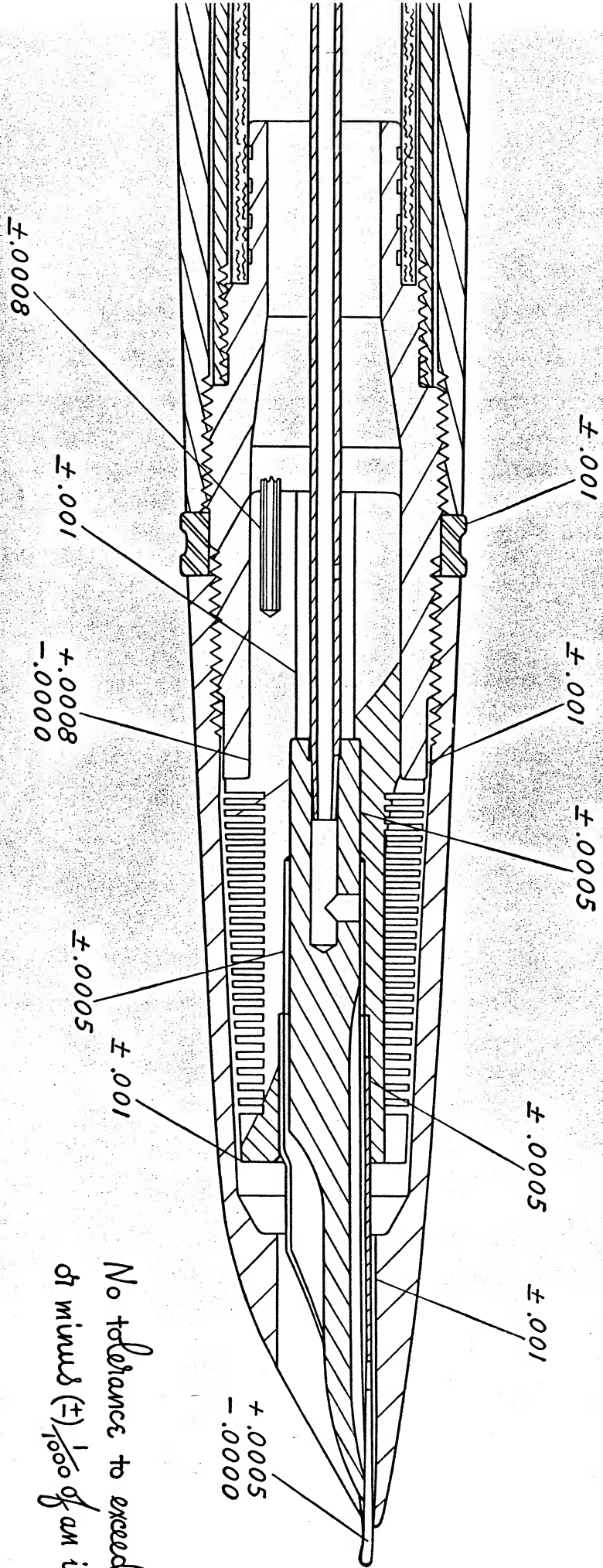

No tolerance to exceed  $\frac{1}{1000}$  of an inch  
or minus ( $\pm$ )  $\frac{1}{1000}$  of an inch

# Beauty

Colors keyed to the most vibrant hues of nature

Extensive research by foremost color experts determined the eight sharp, rich colors presented in the new "51" pens.

These color tones produce the maximum effect of smart distinction. They were used exclusively by such famous artists as Cezanne, Michelangelo, Monet, Remington, and Velasquez. They create an air of informality and harmonize with all other color combinations. Thus, any of the eight colors can be selected with confidence

that they will blend with any shade of wearing apparel or accessories.

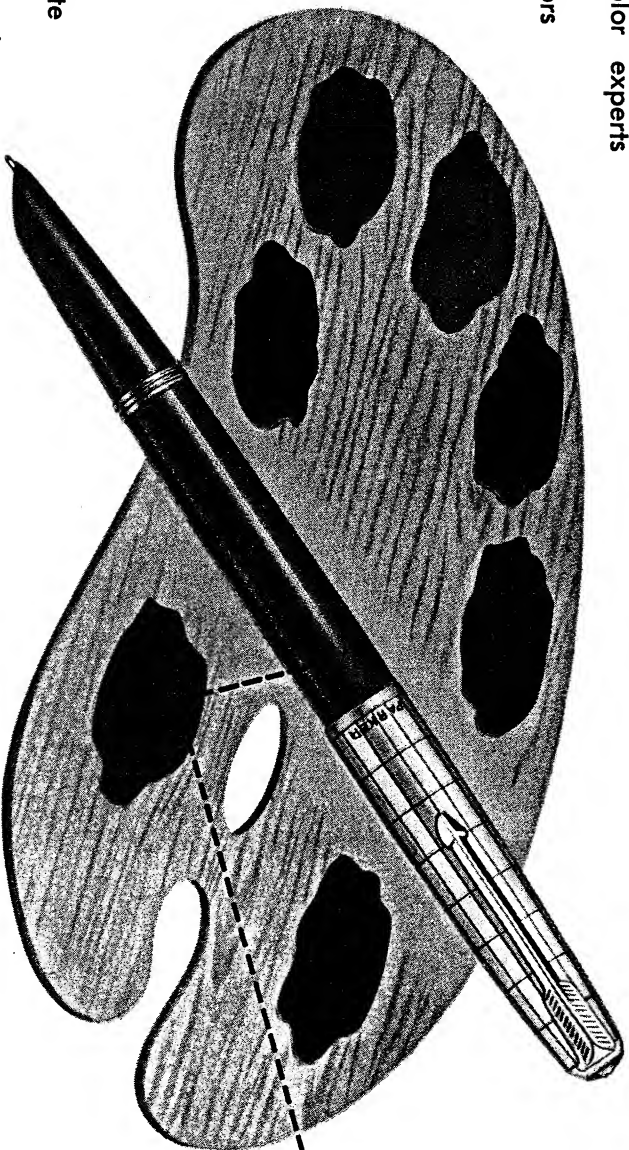

Artist Edmund Lewandowski explains his research and deep understanding in completing the Parker commission: "The beauty and romance of these new Parker colors are truly born of nature. I have tried to capture this pageant of color in the greens, blues, and purples of the minerals, malachite, and azurite found in Arizona . . . the burgundy of the ruby from far-away Burma . . . the cocoa color of tropical fish swimming in the teal blue water of Tahiti's coral gardens . . . the grey and cocoa of the beautiful butterfly *Ornithoptera* of Java. These colors are of the animal, mineral, and vegetable . . . the colors of life."





LEWANDOWSKI

Standard size  
New Parker  
"51"



# NEW PARKER "51" M

The extraordinary appearance of this pen is the result of a calculated blending of richly colored plastics and smart, smooth Lustraloy. And the "51", long the world's most wanted

Standard Size	Pen	Pencil	\$
Black	51-221	51-721	51-
Midlight Blue	51-222	51-722	51-
Navy Grey	51-223	51-723	51-
Cocoa	51-224	51-724	51-
	\$13.50	\$6.75	

Demi-size  
New Parker  
"51"

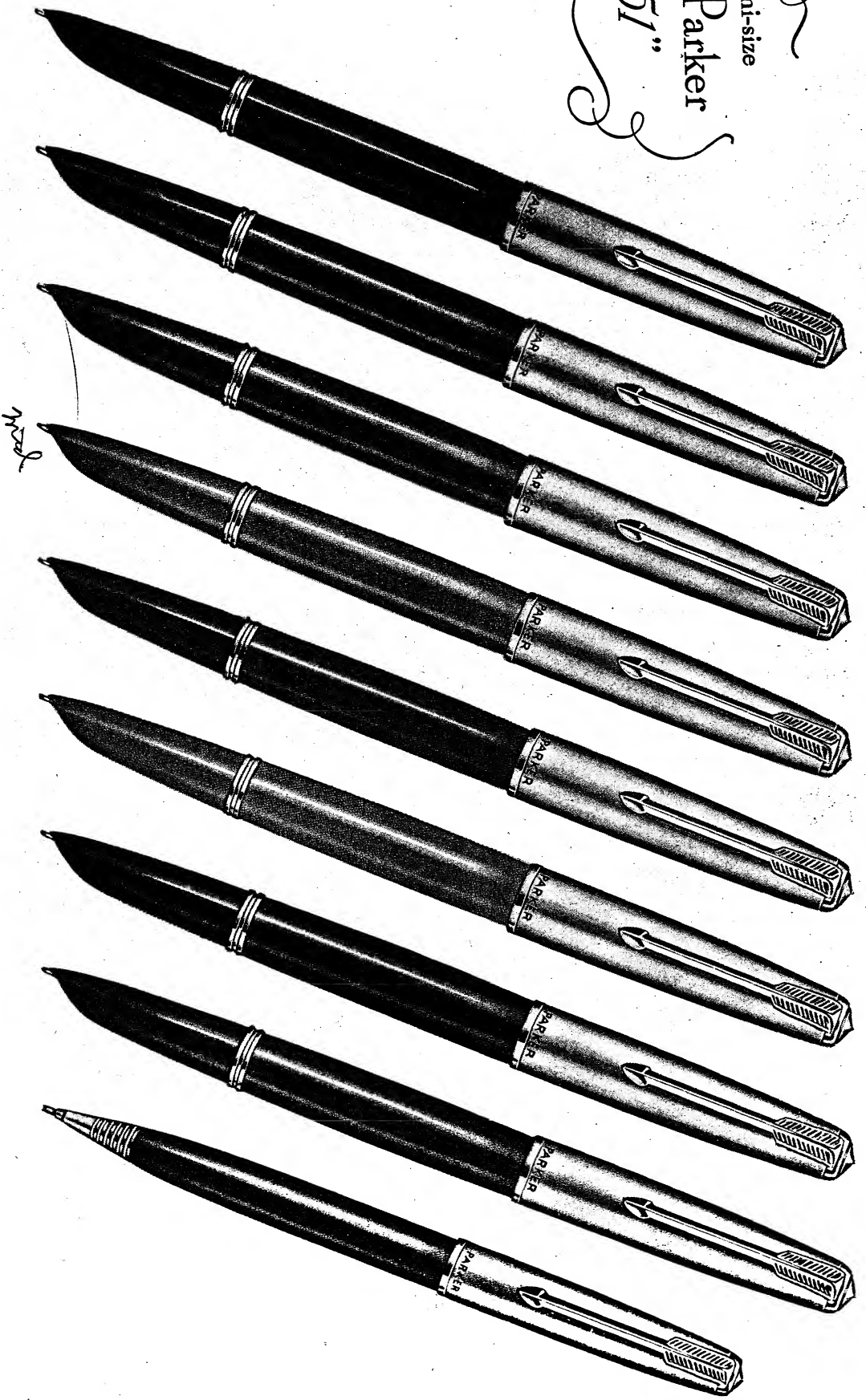

# Lustraloy Cap and Clip

Demi-Size	Pen	Pencil	Set
Black	51-321	51-821	51-321-821
Midnight Blue	51-322	51-822	51-322-822
Navy Grey	51-323	51-823	51-323-823
Cocoa	51-324	51-824	51-324-824

## Protective Hood for Nib

This revolutionary "51" feature furnishes protection for the gold nib . . . just as the casing protects the delicate works of a fine watch. Pen-clogging dust and dirt are excluded. The hood

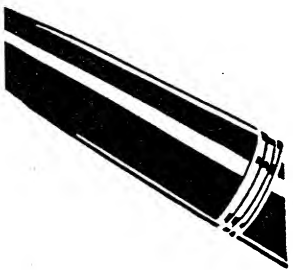



Standard size  
New Parker  
"51"

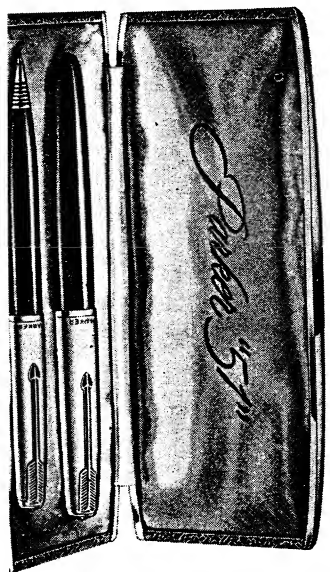
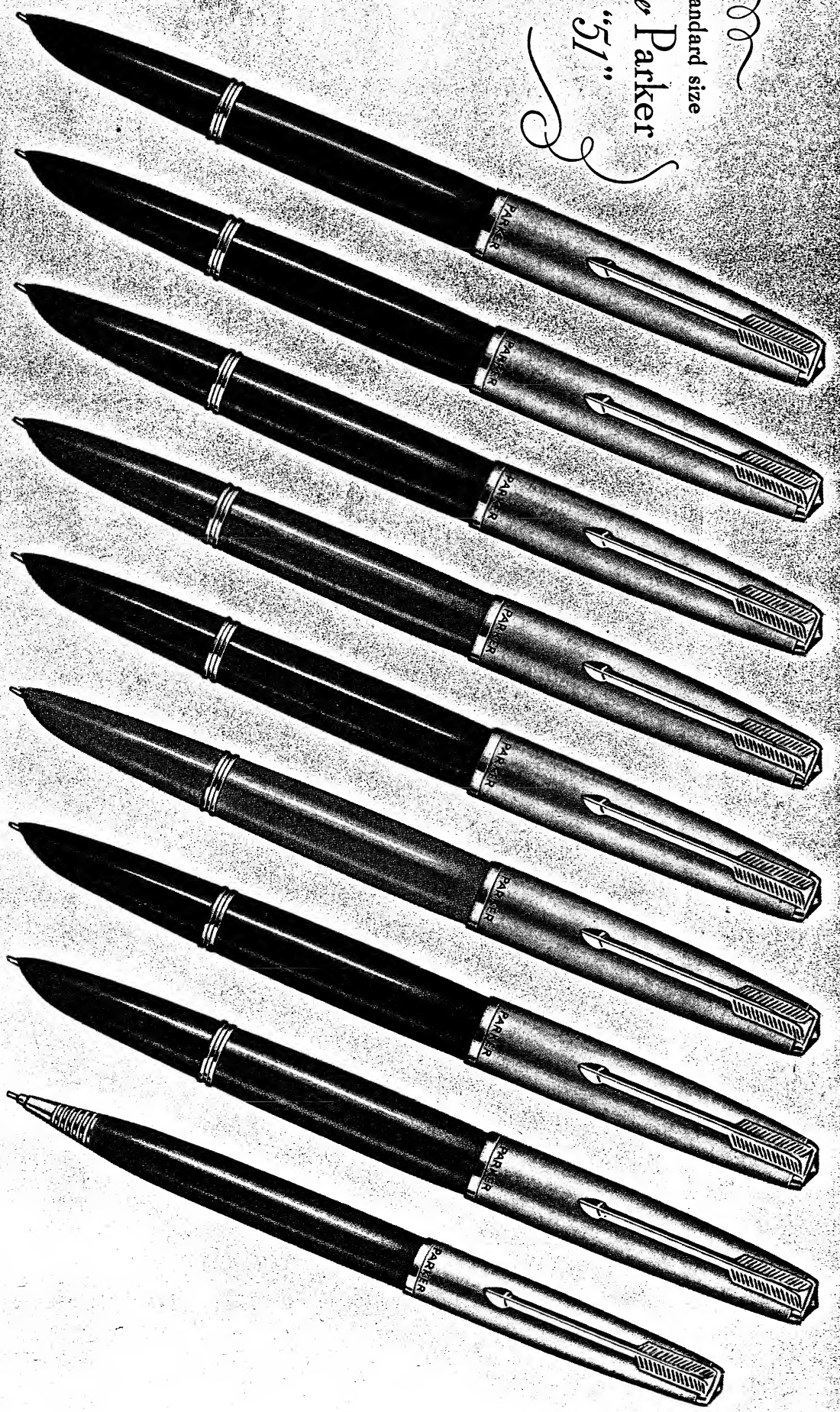

# NEW PARKER "51" wi

Once again Parker combines top writing performance with eye-pleasing beauty. The Gold-filled clip is the perfect finishing touch for this streamlined beauty, a gleaming highlight of rich metal. The "51" starts instantly . . . writes smoothly and affordably.

	Pen	Pencil	Set
Standard Size	\$14.50	\$7.50	\$21.50
Black	51-231	51-731	51-231-7
Midnight Blue	51-232	51-732	51-232-7
Navy Grey	51-233	51-733	51-233-7
Cocoa	51-234	51-734	51-234-7



Demi-size  
New Parker  
"51"

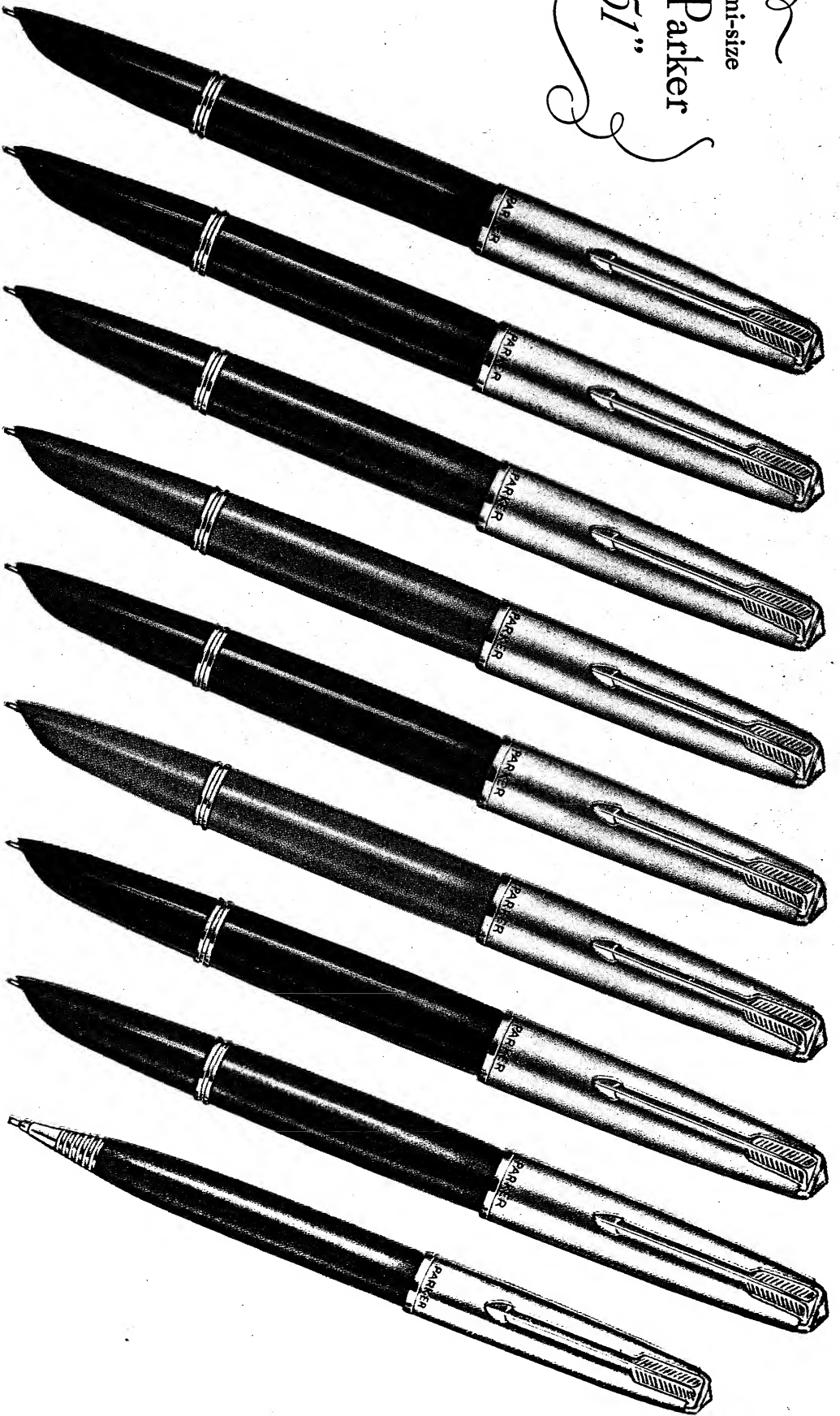

# Australoy Cap and Gold Clip

Demi-Size	Pen	Pencil	Set
Black	51-331	51-831	51-331-831
Midnight Blue	51-332	51-832	51-332-832
Navy Grey	51-333	51-833	51-333-833
Cocoa	51-334	51-834	51-334-834
Forest Green	51-335	51-835	51-335-835
	\$14.50	\$7.50	\$21.50

## Tubular 14K Gold Nib

A new, full-slit nib is freed from all inherent stress by means of a new scientific process . . . thus ensuring permanent true shape. Pliability is improved and feeding is more reliable.

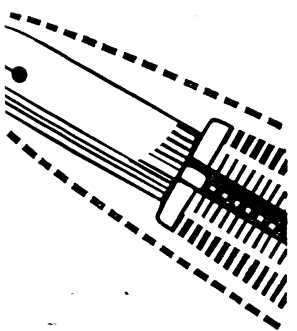

Standard size  
New Parker  
"51"

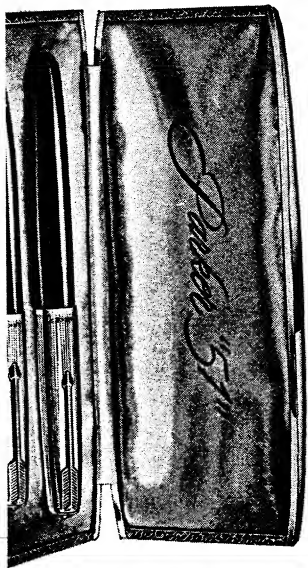
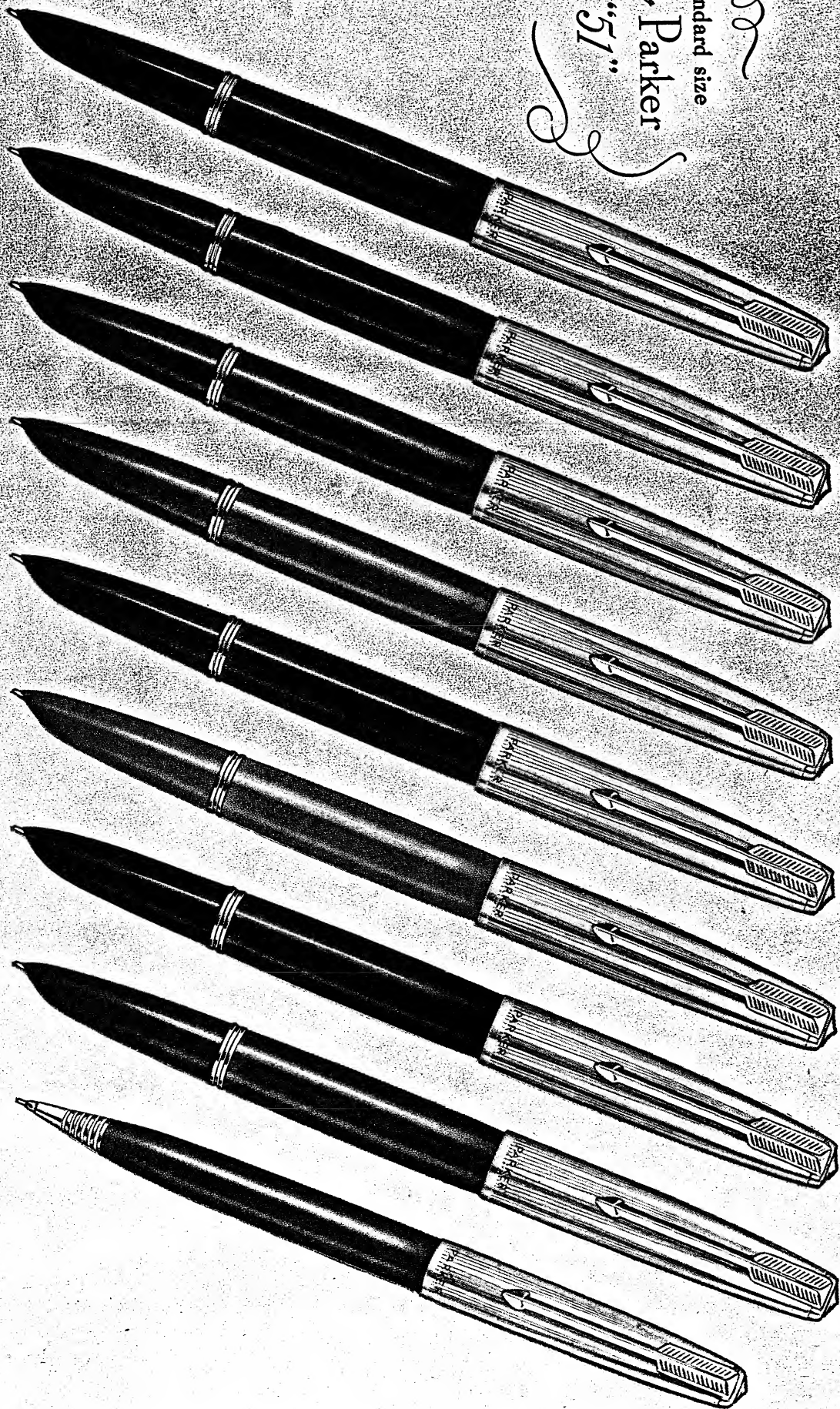

# NEW PARKER "51" wi

This is the sensational Gold-cap Parker "51" . . . a pen without a peer. Groups of converging chased lines give it styling as befits a piece of jewelry. Its dry-writing magic

Standard Size	Pen	Set
Black	51-241	\$29.75
Midnight Blue	51-242	\$29.75
Navy Grey	51-243	\$29.75
Cocoa	51-244	\$29.75

Demi-size  
New Parker  
"51"

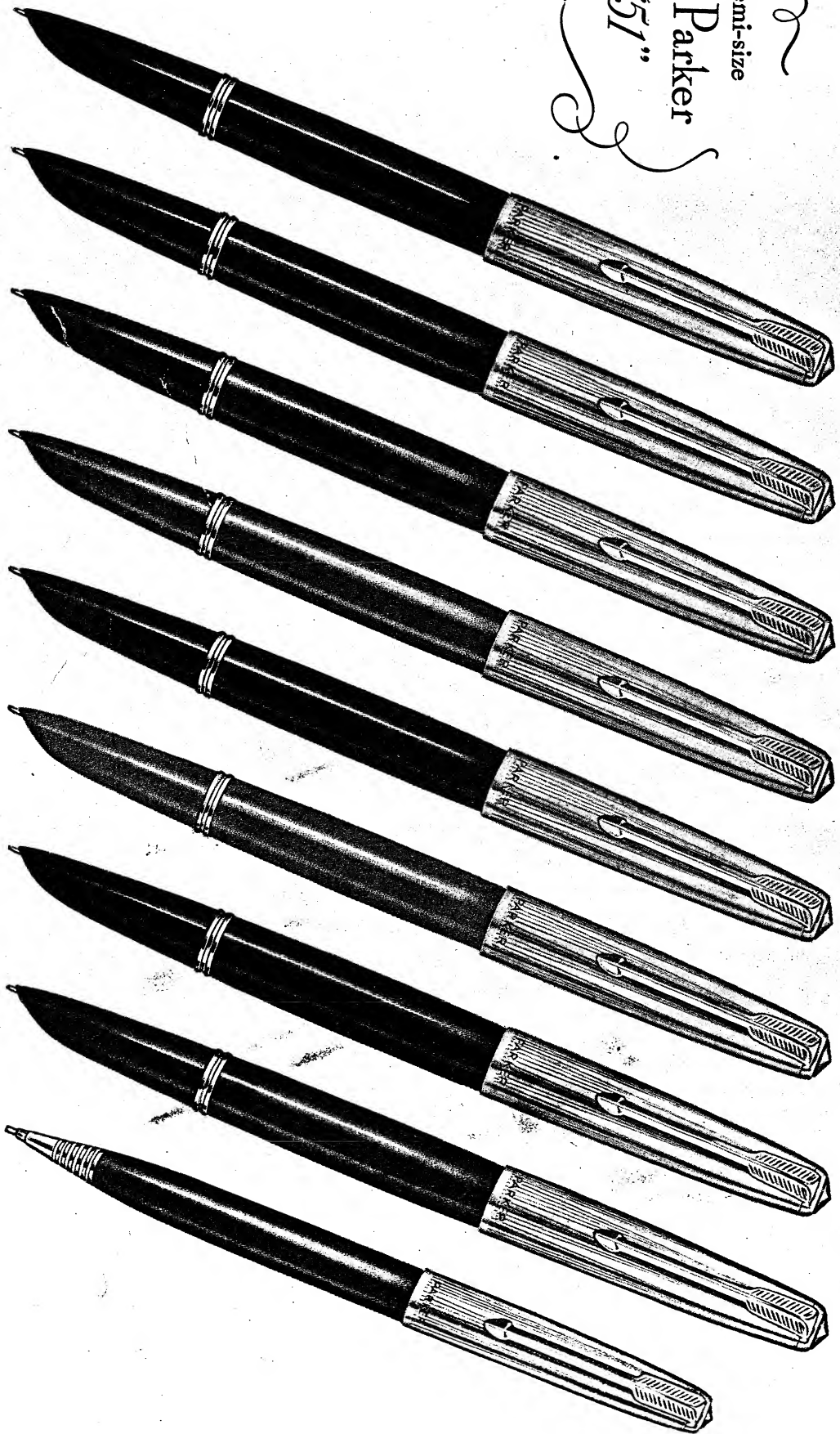

# old-Filled Cap and Clip

	Pen	Pencil	Ball
Black	\$18.75	\$10.80	\$29.75
Midnight Blue	51-341	51-841	51-341-841
Navy Green	51-342	51-842	51-342-842
Charcoal	51-343	51-843	51-343-843
Platinum	51-344	51-844	51-344-844

## Patented Ink Governor

This is the essential part of the ink metering mechanism. It traps any ink overflow INSIDE — making the "51" a pen that normally neither leaks nor floods. Meanwhile, the governor leaves the point unobstructed until ink flows.

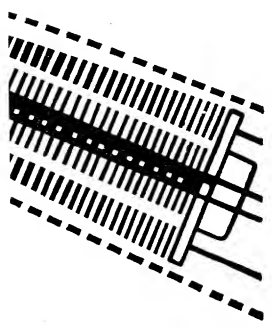





All Gold-Filled  
*New* Parker  
"51"

# NEW PARKER "51"

A style-setting masterpiece with glittering exterior, the new "51" gold Signet set is designed for those who enjoy the finest. Cap, barrel and fittings are 1/10 14K gold-filled. Groups of chased lines form a design which is rich and dramatic . . . highlighted by a signet area for owner's name. The long, strong arrow clip is of gold-filled beryllium copper.

STANDARD SIZE	
Set 51260/760	\$49.75
Pen 51260	\$33.00



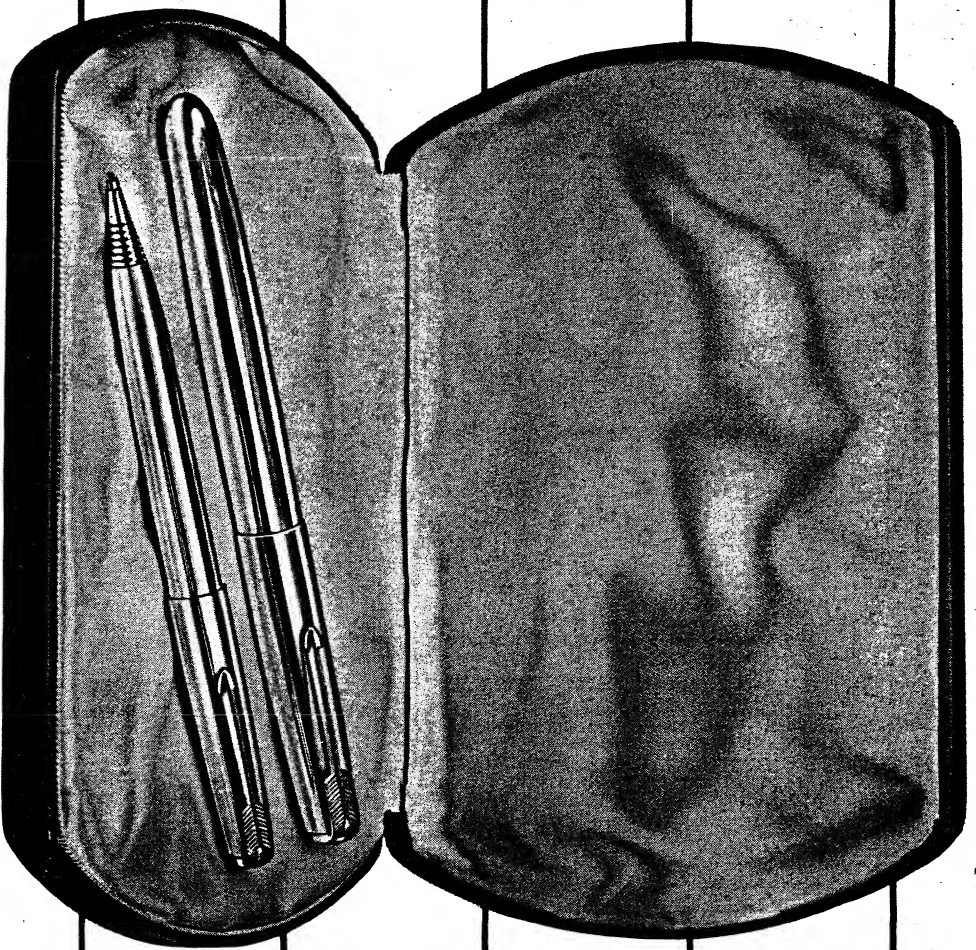

# All Gold-Filled Signet

The standard size gold Signet set is presented in a new, jewel gift case of brown tooled leather. For the demi-size set, there is a dainty jewel gift case of white leather. All functional advantages of the new Parker "51" pen and pencil are present in the gold Signet set.

Standard size \$49.75  
Demi size \$33.00  
Parker 51 \$18.00

Standard size  
New Parker  
"51"

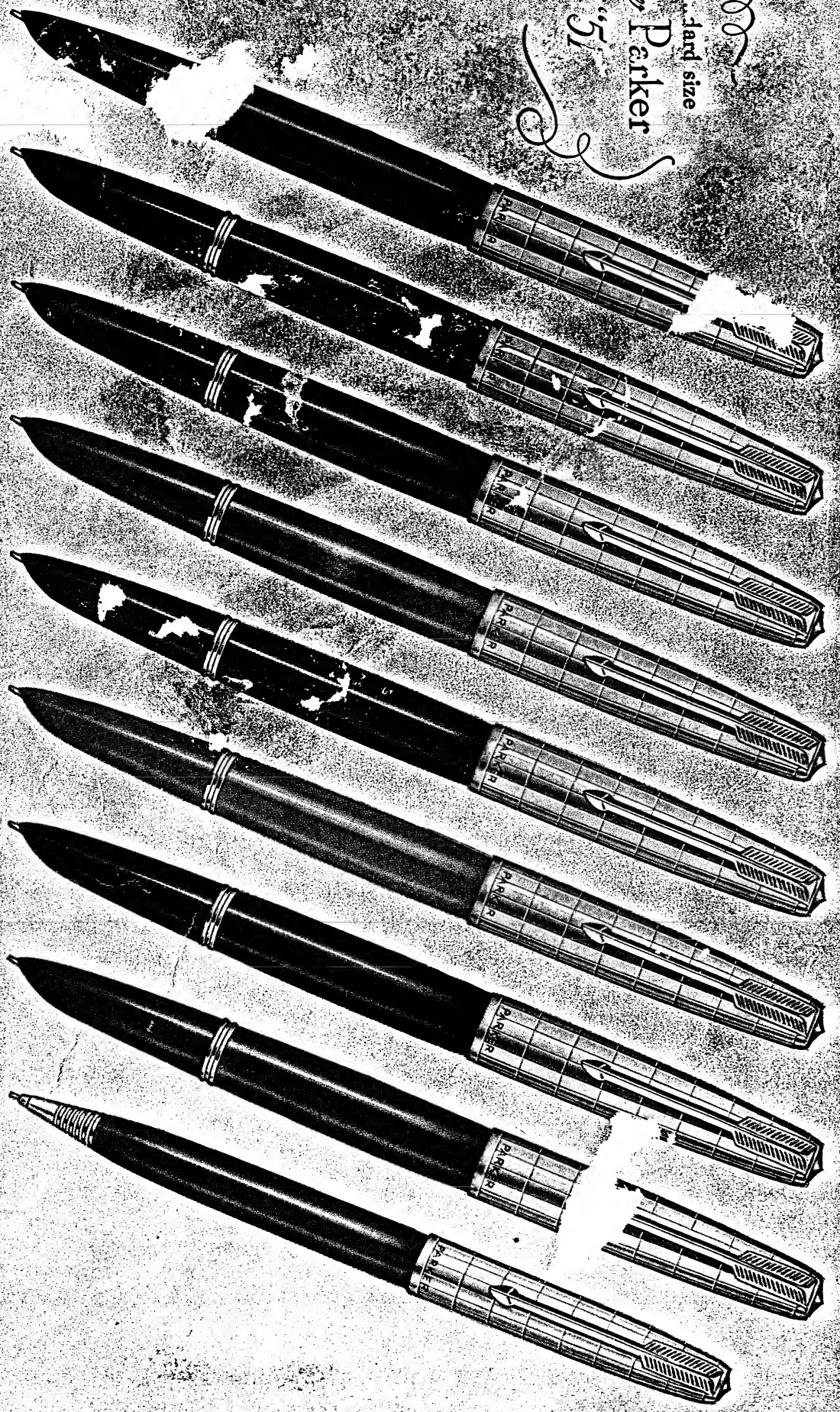

# NEW PARKER "51" Heritage

Nothing in writing instruments could be finer. Its slender lines and perfect balance make writing a pleasure. The elegance of its gold-filled cap is set off with matching gold-filled clip and fittings. Here is, indeed, a Parker master-

Standard Size	Pen	Pencil	Set
Black	51-271 \$25.00	51-771 \$15.00	51-271-771 \$40.00
Midnight Blue	51-272	51-772	51-272-772
Navy Grey	51-273	51-773	51-273-773
Cocoa	51-274	51-774	51-274-774
Forest Green	51-275	51-775	51-275-775
Burundy	51-276	51-776	51-276-776

*Demi-size  
New Parker  
"51"*

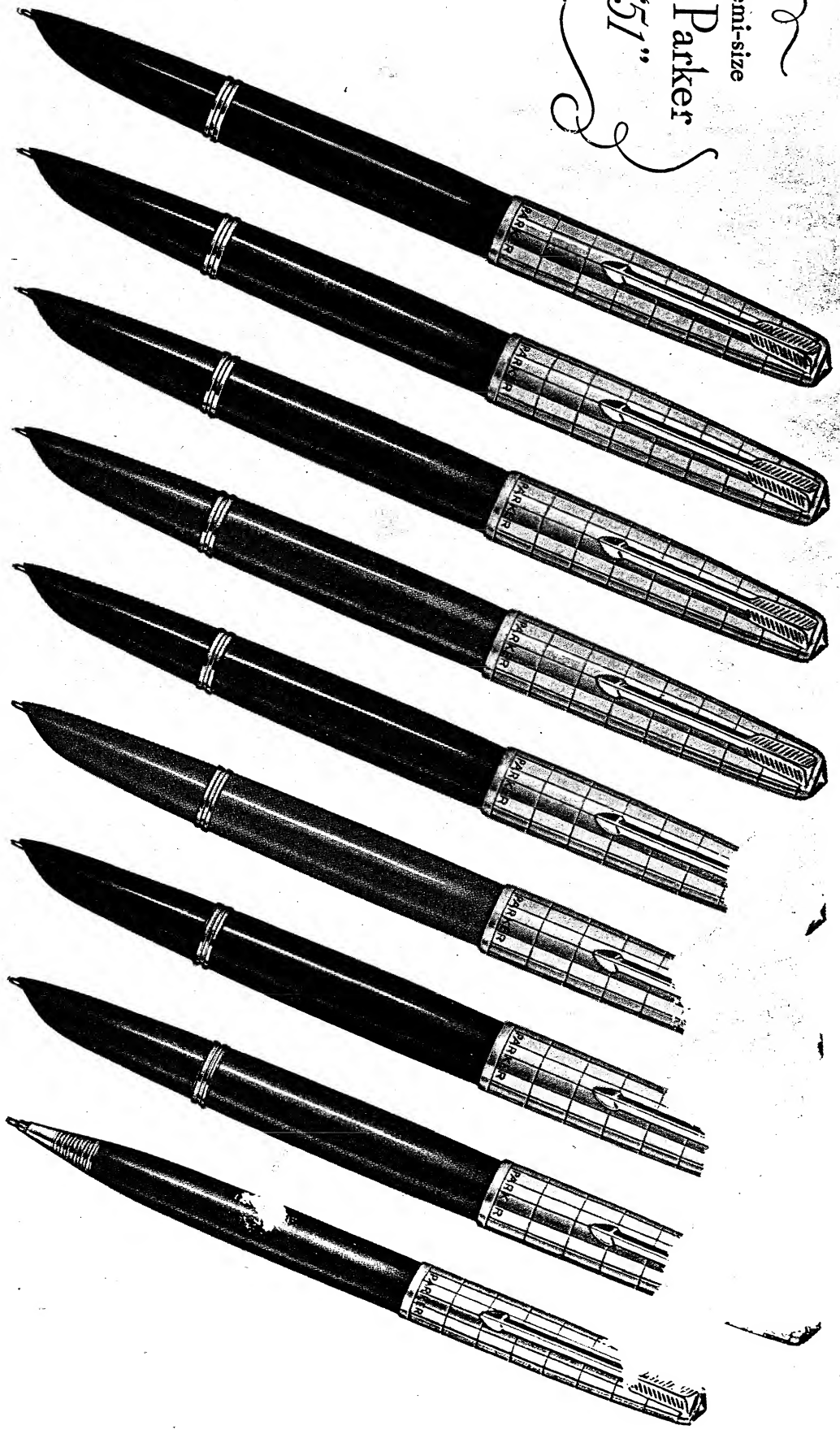

# With Gold-Filled Cap and Clip

Demi-Size	Pen	Pencil	Set
	\$25.00	\$15.00	\$40.00
Black	51-371	51-871	51-371-871
Midnight Blue	51-372	51-872	51-372-872
Navy Grey	51-373	51-873	51-373-873
Cocoa	51-374	51-874	51-374-874
Forest Green	51-375	51-875	51-375-875

## Increased Resistance to Conductive Heat

Ultra modern scientific design plus new Parker-developed materials combine to produce remarkable insulating properties in the new "51". Tests have shown the new

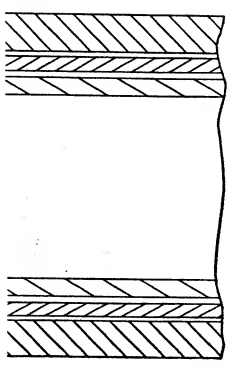



Standard size  
New Parker  
"51"

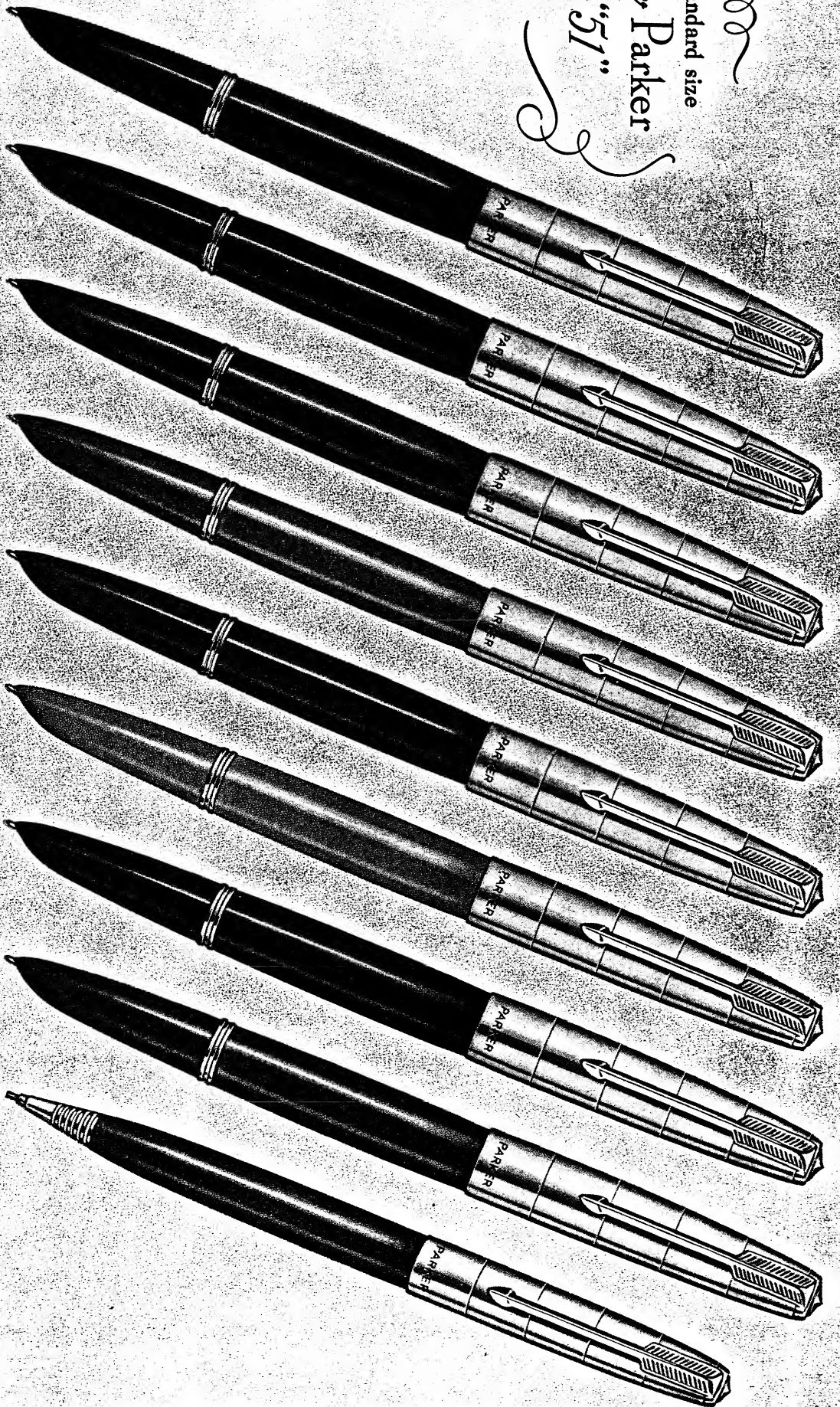

# NEW PARKER "51" Heirloom W

The pen you've always wanted . . . the aristocrat of all writing instruments. Made of the richest materials with the finest craftsmanship. Glides smoothly and silently across the paper and writes dry with wet ink. It's fit for a maharajah.

Standard Size	Pen	S.S.
	\$50.00	\$96.
Black	51-281	51-281
Midnight Blue	51-282	51-282
Navy Grey	51-283	51-283
Cocoa	51-284	51-284
Forest Green	51-285	51-285
	51-286	51-286



Demi-size  
*New* Parker  
 "51"

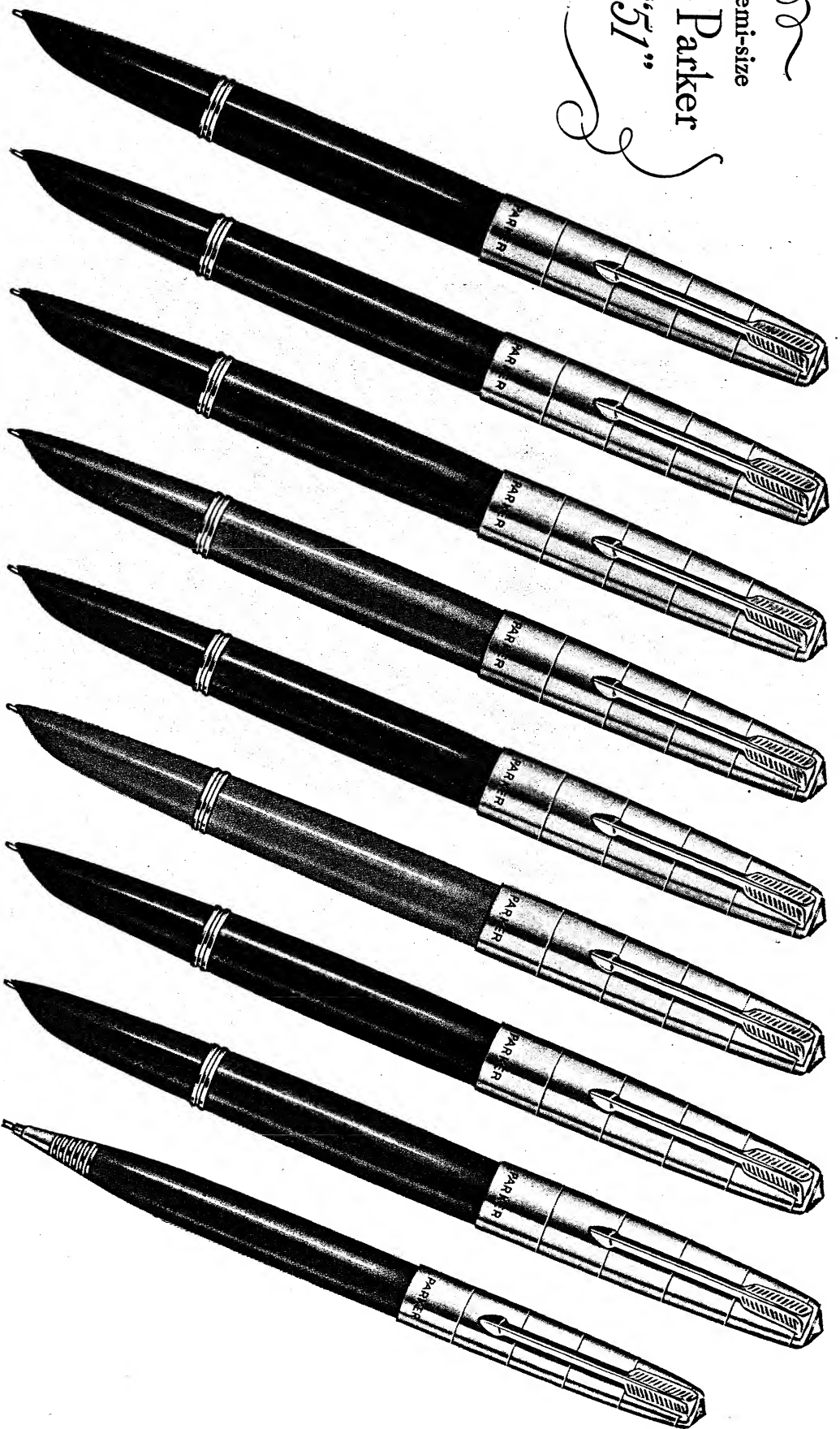

# Solid Gold Cap and Matching Clip

Pen	Pencil	Set
\$1,385	\$26.00	\$1,381.881
\$1,382		\$1,382.882
\$1,383		\$1,383.883
\$1,384		\$1,384.884
\$1,385		\$1,385.885

## Increased Write-Out Ability

The Pl-glass reservoir will not retain ink on its inner surface like other ink reservoirs. In automatic writing tests, the new "51" utilizes approximately 98% of the ink content.

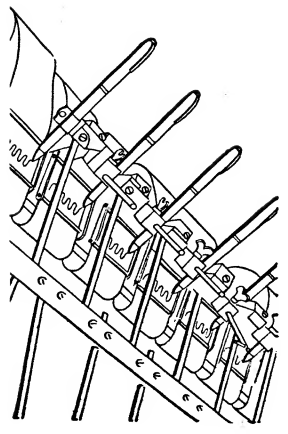

# 7 Individualized Custom Points

to make your handwriting individual as your thumbprint



Now the distinguished Parker "51" comes in a choice of 7 different points . . . ranging from "accountant" to "stub." Each point is designed to suit a different style of handwriting. Each is precision-ground to glide smoothly across paper. A new, full-slit nib improves pliability and gives more reliable feeding. With this full-slit nib, a greater overlap on the feed bar is possible . . . important in ensuring good writing performance. Choose your Parker point and you are assured a micro-smooth point which will make your handwriting individual as your thumbprint.

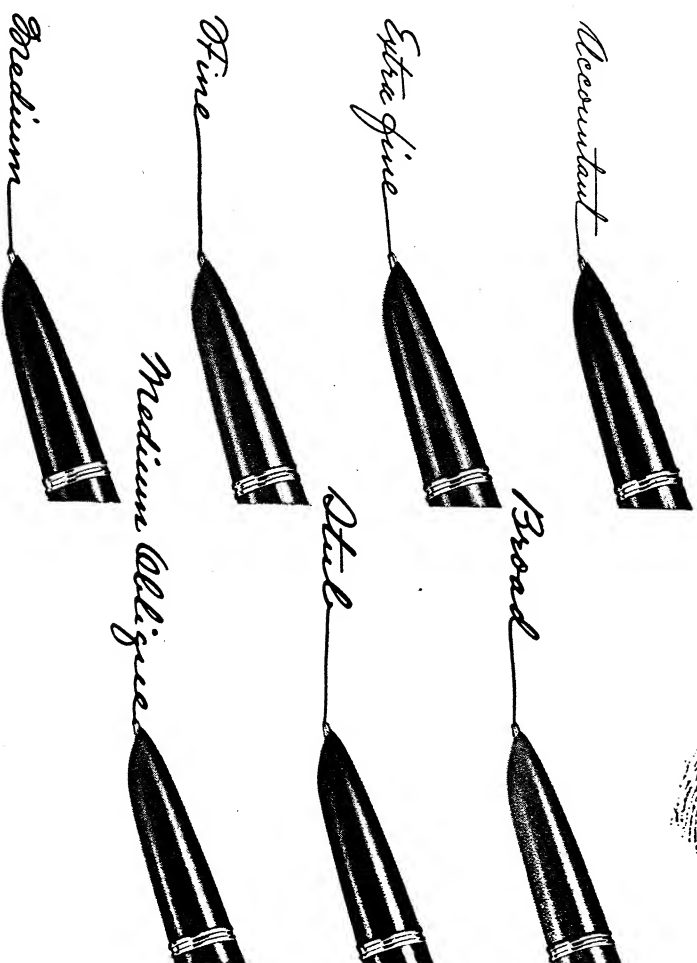

## Molecular science at your service

The illustration at left shows the hexagonal structure of atoms in the exclusive metal used by Parker for the manufacture of point tips. Called *Plathenium*, this metal is extra dense to provide smoothness. Studies of the molecular structures of precious metals by our metallurgical technicians

produced this scratch-resistant material. These experts blended soft, workable Platinum with durable Ruthenium to obtain an alloy perfect for pen point use. This alloy — *Plathenium* — is the basis for the satin-smooth, dependable writing achieved by all the new Parker "51" pens.

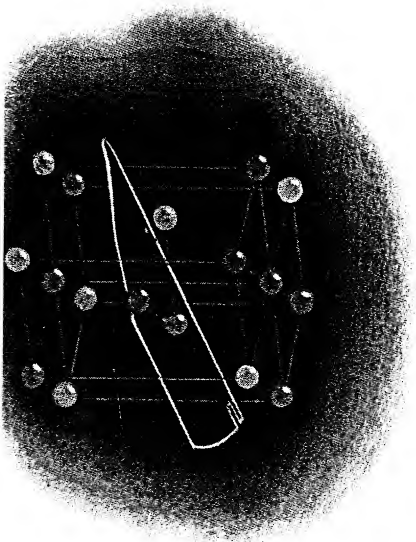

# pressure control

"51" with these new scientific developments

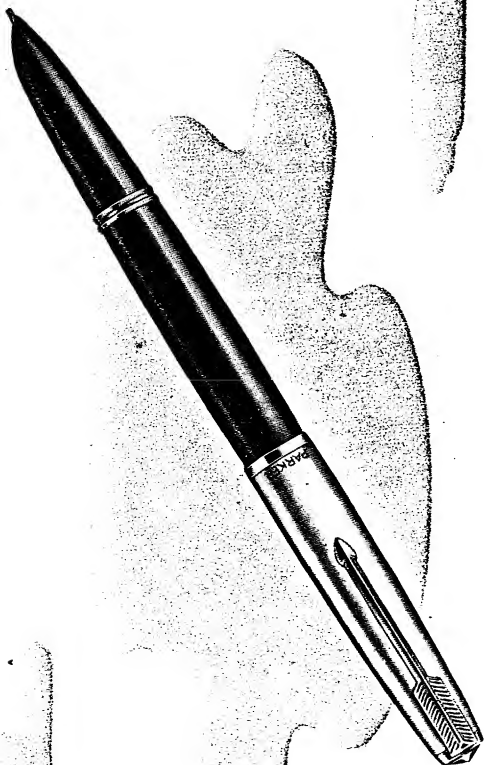

## New—Simple "Easy-Press" Filler

For years, complicated filling has troubled pen owners, dealers, and manufacturers alike. Now, the new Parker "51" banishes this trouble by reducing the filling technique to its simplest terms. It's as easy as pressing your fingertips together 6 times. This squeezing action on the ribbed metal bar fills the Parker Pl-i-glass ink reservoir with complete certainty.

### TO FILL THE NEW PARKER "51":

*Unscrew pen barrel at clutch-ring, as shown in small illustration. Then, press ribbed bar firmly, 6 times. Use dry-writing Superchrome ink. Instructions are engraved on the reservoir's protective guard.*

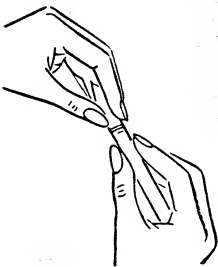

# The New PARKER "51" with *Flow-Motion*

combines the finest features of the original P

## New—Parker Pi-Glass Reservoir

At last the chronic "rubber-sac problem" of the pen industry has been solved with the Parker Pi-glass reservoir. Even after years of improvement, rubber sacs were still unable to resist some inks, and deteriorated rapidly. Gradually rubber sacs were supplemented by other filling mechanisms. These, too, proved annoying

Now a new, durable material formulated in Parker laboratories by John J. Dysor simplifies the filling process. This exclusive Parker development, called Parker Pi-glass, is many times more age-resistant than other materials. Laboratory research indicates that it will last at least thirty years in normal usage. It's transparent so ink can be seen. And, best of all, this new material augments the complete flow of ink from the reservoir to the writing point. This scientific development has made possible the simple "easy-press" filling feature of the new Parker "51".

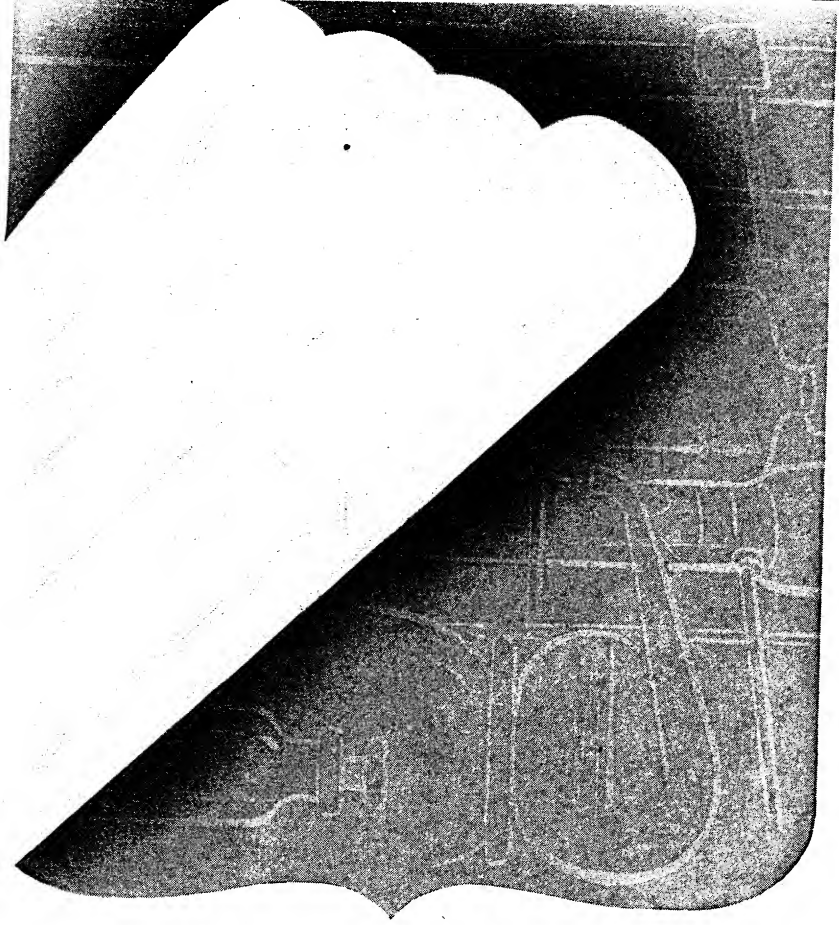

# NEW PARKER "51" Repeater Pencil

This entirely new-and-different Parker "51" Repeater Pencil is the perfect mate for the new "51" pen. It gives unusually fine service with a minimum of attention. Writes for months without refilling. This is because it can successively utilize 10 to 12 leads with a single manual filling. On this basis, the "51" Repeater Pencil provides 10 times as much continuous writing as previous models.

The lead ejecting mechanism is actuated by a telescoping inner-barrel. By employing this unique method, the external design of the pencil is matched to the "51" pen. Simple to operate, this ejector has a new, strong clutch which holds lead firmly; prevents wobbling, slipping, and uneven wear of lead.

The pencil is equipped with an exceptionally long, adjustable eraser — equivalent in erasing action to 4 standard size erasers. Ideal for salesmen, students, and clerks, this new "51" Repeater Pencil is slender and beautifully designed with emphasis placed on finger-ease and comfortable writing balance. Colors, clips, and caps match the pens.

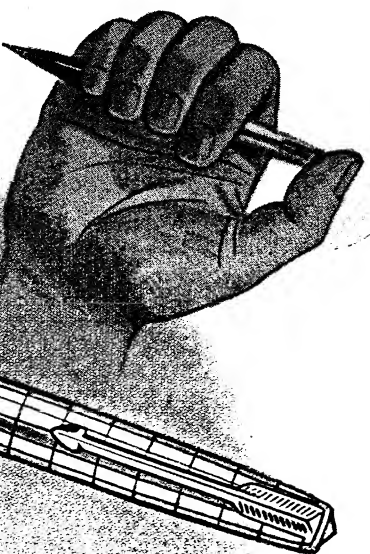

To eject lead:  
Depress top of  
pencil, as shown.

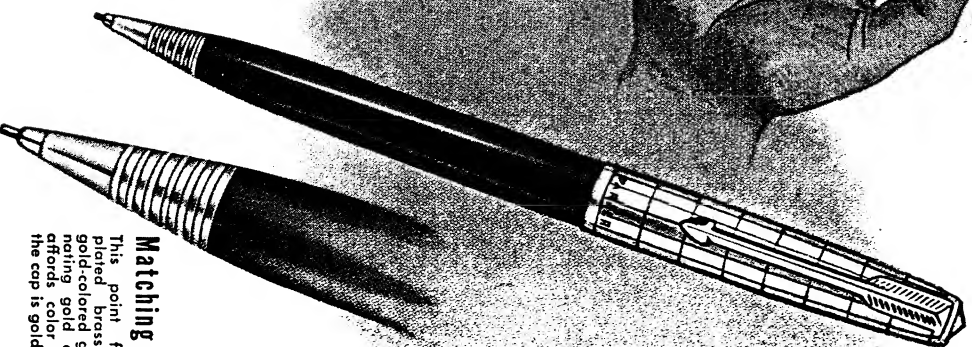

**Matching Metal Point**  
This point features chromium plated brass with concentric gold-colored grooves. This alternating gold and silver pattern of Florida color harmony, whether the cap is gold-filled or Lustraloy.

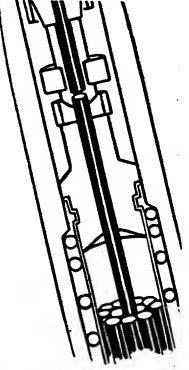

**Constant-Grip Lead Clutch**  
Constant spring action on the clutch causes it to firmly grip the lead in its 3-pronged clutch. Lead cannot turn in the pencil. The clutch also prevents lead from slipping back on the pencil regardless of pressure used.



**Gravity-Activator Lead Feed**  
Lead is funneled into position by force of gravity. There, it is gripped by an activating mechanism which expels it automatically into the 3-pronged clutch. In that position, lead is always ready for dependable writing service.

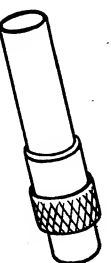

**Long Adjustable Eraser**  
The eraser, a full 1 inch in length, has an adjustable collar which can be regulated to obtain a desired length.



# PARKER Superchrome INK

FOR THE PARKER "51" PEN ONLY

Here's the new dry writing ink created for the Parker "51" only. Up to 60% more brilliant than ordinary inks. The 5 tropic-bright colors of new Parker Superchrome ink are sharp and clear. And, they stay this way as long as the paper lasts. Equally remarkable - this amazing new ink actually "dries as it writes." No need for a blotter. Here is an added reason why more people are choosing the Parker "51".

## Dry Writing

The ink dries by vertical penetration - not by evaporation. Dries up to 3 times faster than ordinary inks. No blotter is ever needed.

## Super-Brilliance

Colors up to 60% more brilliant than ordinary inks. Dye content 3 to 10 times greater as compared with ordinary inks.

## Super-Permanence

Even times more resistant to fading, on the average, than government standards require.

Color:	Super Red;	Super Blue-Black;	Super Green;	Super Blue;	Super Black.
Size	1 oz.	50c each	3 doz.		
Retail Price					
List Price					
		\$6.00 per doz.			

Shipping Wt. approx. 34 lbs.

50¢ for year's supply



## PARKER QUINK CONTAINING SOLV-X

Quink cleans a pen as it writes

Light, quick-drying Parker Quink protects pens from gumming, clogging, metal-corrosion, and rubber-rot because it contains solv-x. Prevents to 65% of pen damage. Quink is light-fast and water resistant and contains no sediment, so it is perfect for fountain pens. Quink makes pens last longer too. Quink shipments are



## What is SOLV-X?

A scientific, secret formula of mild solvents and humectants, or moistening agents, developed by Parker scientists especially for

## COLORS

Permanent	Black	Blue-Black
Washable	Blue	Black
	Green	

## PRICES

Retail	List	Dealer Cost
Each	Per Dozen	Per Dozen
\$ .25	\$3.00	\$1.80
.35	4.20	2.52

-----  
**the new Parker "51" with**

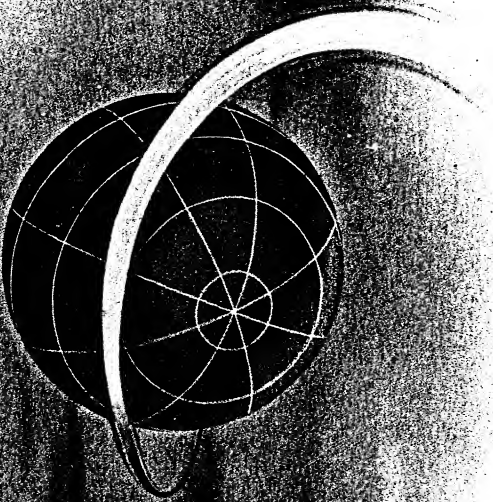

**zero-metric pressure control**